

## HOBIE H14 / H16

REPLACEMENT HULL H16 WHITE - LEFT  
25010001  
REPLACEMENT HULL H16 WHITE - RIGHT  
25020001

Decals -  
12452161 "16" Silver  
12452121 "Hobie Cat" Black  
12451061 "Hobie" Diamond 36" Silver  
12452000 Silver pin stripe (ft)

Older Decals -  
12452160 "16" Silver  
12451130 "Hobie" Red Each  
12451021 "Hobie" Diamond 36" Red  
12452000 Silver pin stripe (ft)

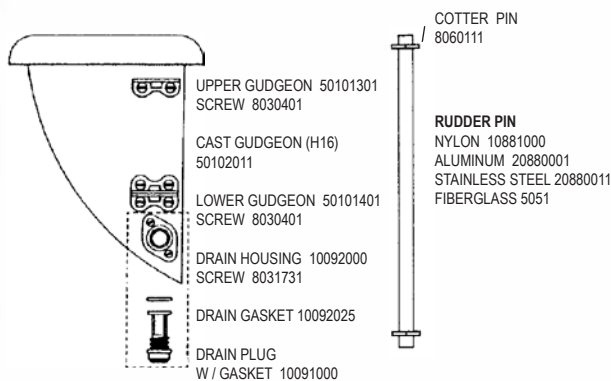
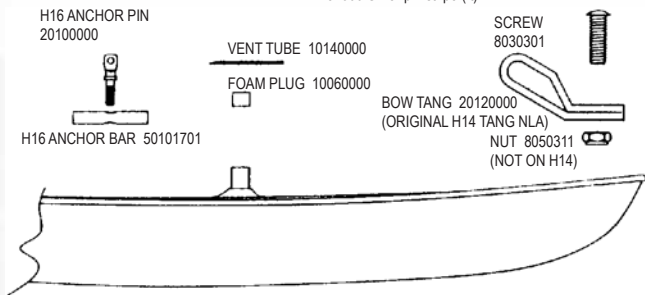

### H14 / H16 TRAMPOLINE, SIDEBAR

H14 COMPLETE TRAMPOLINE (Does not include lace lines) 1097XXXX (XXXX = Color / See parts list for available options)

H16 COMPLETE TRAMPOLINE (Does not include lace line) 2097XXXX (XXXX = Color / See parts list for available options)

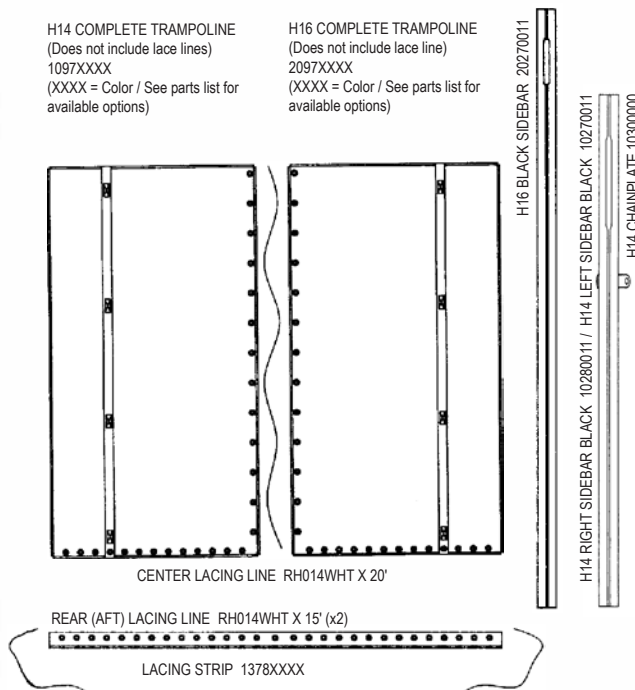

### H14 / H16 FRONT CROSSBAR

H14 BLACK FRONT CROSSBAR W/MAST STEP 10131910  
H16 BLACK FRONT CROSSBAR W/MAST STEP / INTEGRATED TRACK 25131910

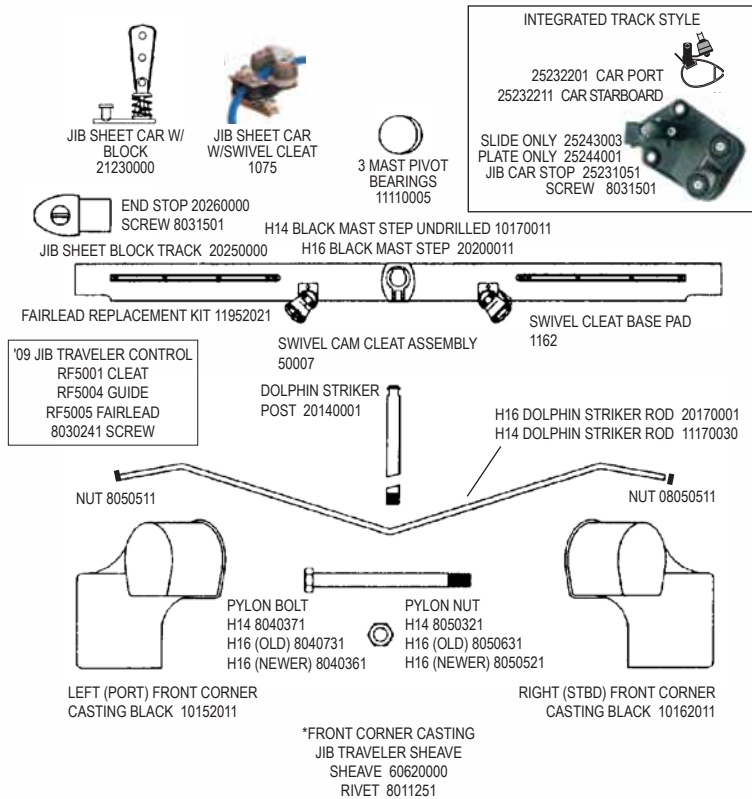

### H14 / H16 REAR CROSSBAR

CROSSBAR EXTRUSION w/ INTEGRATED TRACK, REAR (AFT) WITHOUT CORNER CASTINGS, BLACK - INCLUDES CAR ACCESS PLATE  
H16 25191911  
H14 10191910  
'94 AND NEWER CAR ACCESS PLATE 11810011

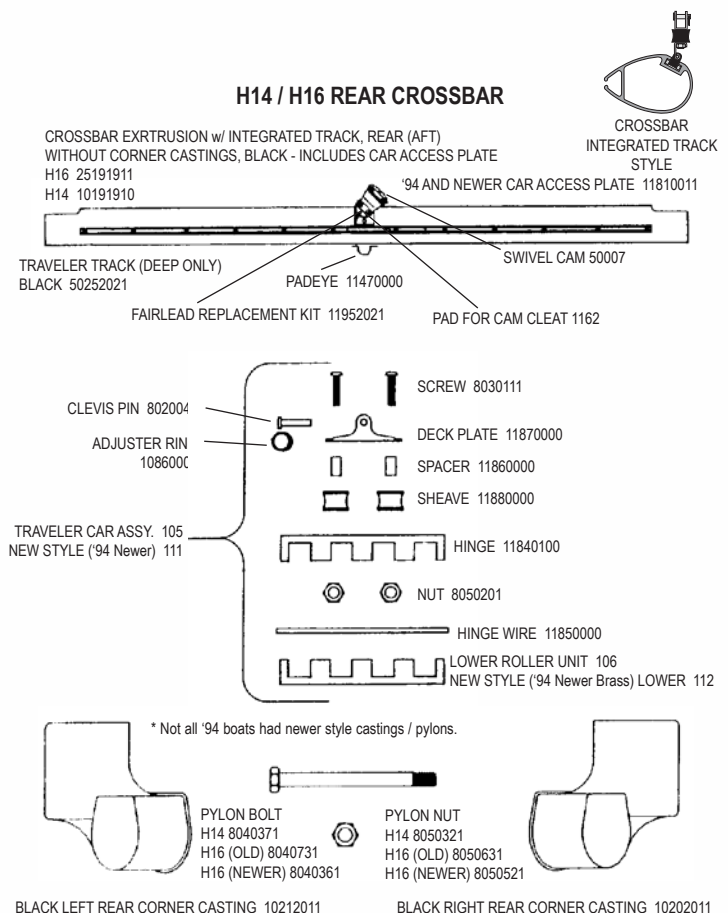

## H14 / H16 RUDDER

\* = SUB ASSEMBLY PART / INCLUDED WITH CASTING

## MIRACLE CONNECTORS

TILLER CONNECTOR ROD 40530001  
 WASHER 8080681  
 TILLER ARM INSERT 40660001  
 BOLT 8040171  
 WASHER 8080691  
 INSERT BEARING 40680001

TILLER ARM SWIVEL  
 END CAP 40650001

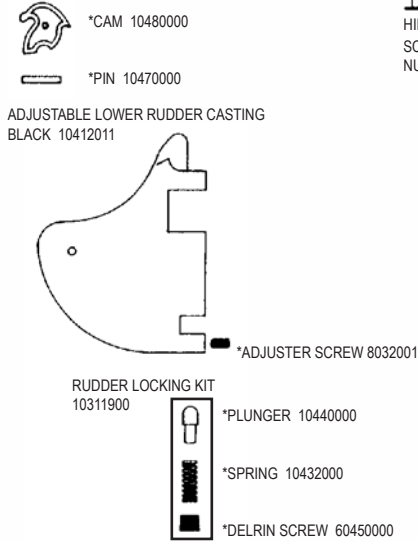
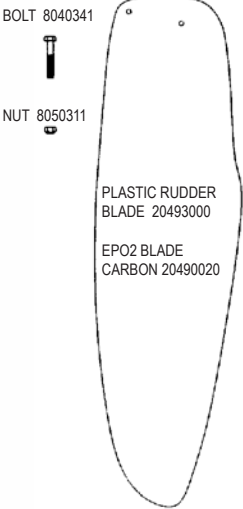
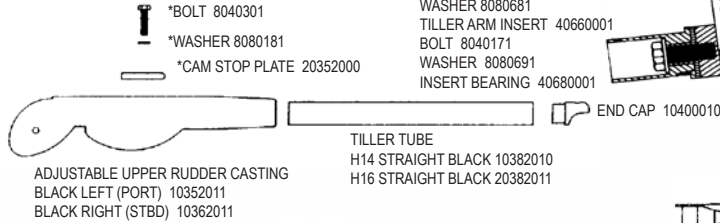

## H14 / H16 TILLER CROSSBAR

H14 TILLER CROSSBAR BLACK 10520011  
 H16 TILLER CROSSBAR ORIGINAL BLACK 20520011

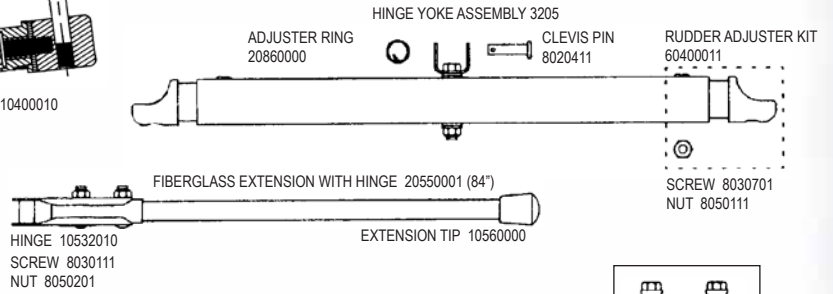

## MIRACLE STYLE TILLER CROSSBAR

H16 TILLER CROSSBAR NEWER - MIRACLE 20521001  
 TILLER CONNECTER KIT 1953

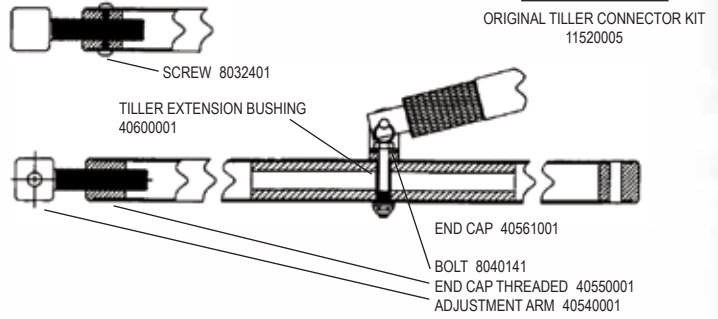

## H14 / H16 MAST

H14 COMPLETE MAST ASSEMBLY BLACK 10581100  
 H14 COMPTIP ASSEMBLY 10582100  
 H16 COMPLETE MAST ASSEMBLY BLACK 20610000  
 H16 COMPTIP ASSEMBLY 20611000

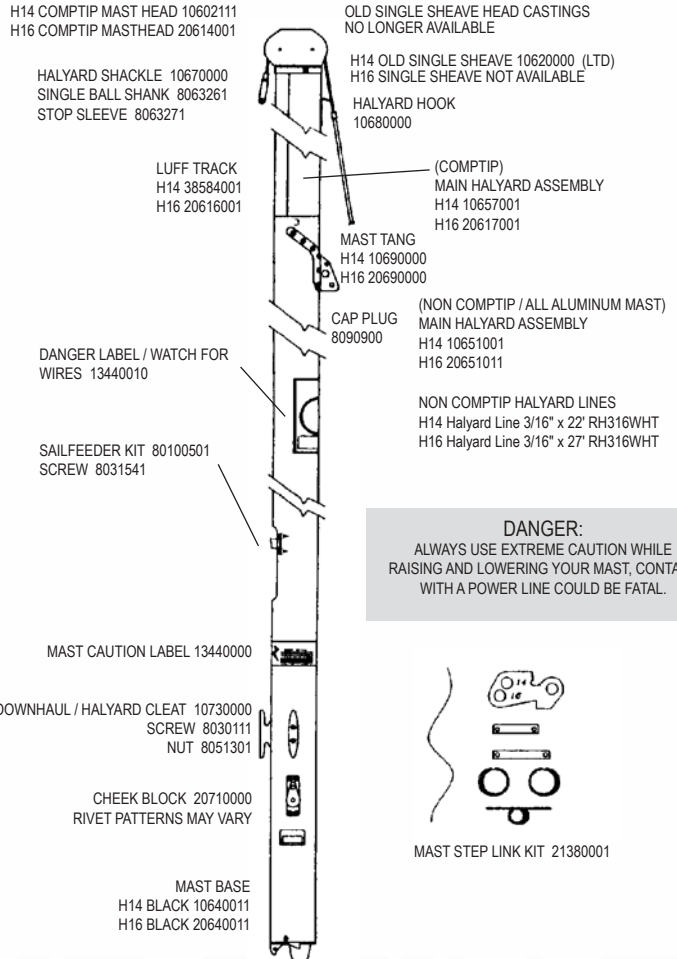

### H14 Rivet Guide

( ) = Quantity needed to fasten part

H14 Rivet Guide	
( ) = Quantity needed to fasten part	
<b>Mast</b>	
Head	8010131 (2)
Halyard Hook	8010181 (2)
	8011291 (2)
Tang	8010181 (6)
	8011291 (6)
Halyard Cleat	8010121 (2)
Base	8010131 (3)
<b>Sidebar</b>	
Chain Plate	8010181 (3)
<b>Rear Crossbar</b>	
Corner Casting	8011231 (6)
Traveler Track	8010201 (18)
or	8010161 (18)
Pad Eye	8010181 (2)
Swivel Jam Cleat	8010201 (1)
	8031501 (2)
	8031231 (1)
	8050801 (1)
	8080101 (1)
<b>Boom</b>	
Front End Cap	8010131 (3)
Tang	8010181 (4)
Barrel Cleat	8010181 (2)
Block Hanger	8010181 (4)
Rear End Cap	8010131 (3)
<b>Front Crossbar</b>	
Mast Step	8011231 (4)
Corner Casting	8011231 (6)
<b>Rudder Assembly</b>	
Upper Casting	8010131 (2)
(Underside)	8011231 (1)
Tiller End Cap	8010131 (2)
<b>Sail</b>	
Headboard	8010020 (16)
Tack/Clew plate	8010020 (6)
Pocket Protector	8010020 (4)
(Requires setting machine-not available as hand tool)	

### H16 Rivet Guide

( ) = Quantity needed to fasten part

H16 Rivet Guide	
( ) = Quantity needed to fasten part	
<b>Mast</b>	
Head	8010131 (4)
Halyard Hook	8010181 (2)
	8011291 (2)
Tang	8010181 (12)
	8011291 (12)
Halyard Cleat	8010121 (2)
Base	8010131 (3)
Downhaul Cheek Block	8010181 (4)
<b>Front Crossbar</b>	
Corner Casting	8011231 (6)
Mast Step	8011231 (4)
Jib Track	8010201 (6)
Swivel Jam Cleat	8010201 (1)
or	8010131 (1)
	8031501 (2)
	8031231 (1)
	8050801 (1)
	8080101 (1)
<b>Rudder Assembly</b>	
Upper Casting	8010131 (2)
(underside)	8011231 (1)
Tiller End Cap	8010131 (2)
<b>Boom</b>	
Front End Cap	8010131 (3)
Tang	8010181 (4)
Barrel Cleat	8010181 (2)
Block Hanger	8010181 (4)
Rear End Cap	8010131 (2)
<b>Rear Crossbar</b>	
Corner Casting	8011231 (6)
Traveler Track	8010201 (20)
Pad Eye	8010181 (2)
Swivel Jam Cleat	8010201 (1)
	8031501 (2)
	8031231 (1)
	8050801 (1)
	8080101 (1)
<b>Sail</b>	
Main Headboard	8010020 (16)
Tack/Clew Plate	8010020 (6)
Main Pocket Prtc	8010020 (4)
Jib Clew Plate	8010020 (16)
Jib Pocket Prtc	8010020 (3)

- H14 FORESTAY BLACK 10812101
- H16 UPPER FORESTAY (PIG TAIL) 20810011

## H14 / H16 SHROUDS

### H16 JIB HALYARD AND LOWER FORESTAY

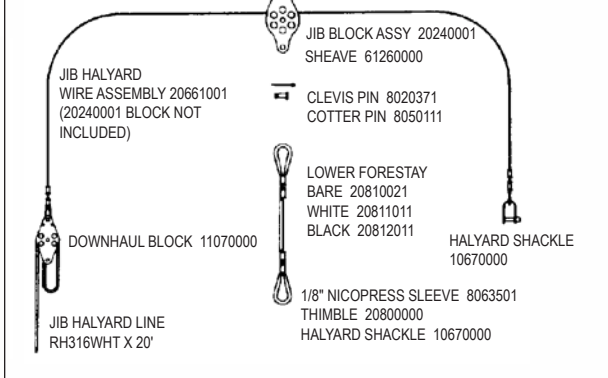

### H16 "AUSSIE" FORESTAY AND JIB HALYARD

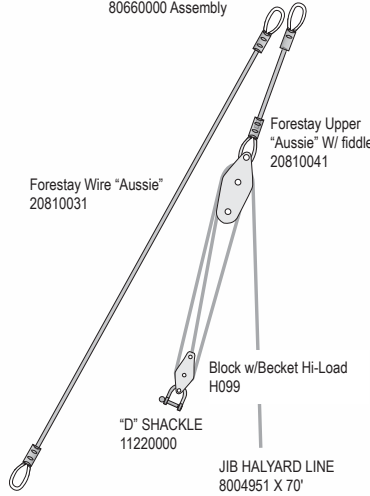

- H14 SHACKLE 10700000
- H16 SHACKLE 20700001
- H14 SHROUD BLACK 10792100
- H16 SHROUD WHITE 20790011
- H16 SHROUD BLACK 20792011
- 1/8" NICOPRESS SLEEVE 8063501
- THIMBLE 20800000
- CLEVIS PIN 8020381
- RING DING 20860000
- 7 HOLE STAY ADJUSTER 20830010
- CLEVIS PIN 8020371
- RING DING 20860000
- TWIST TOGGLE 20210000
- CLEVIS PIN 8020381
- RING DING 20860000

- PIN AND RING SET 30303
- CLEVIS PIN 8020381
- RING DING 20860000
- 10 HOLE STAY ADJUSTER 20830020
- H14 BRIDLE BLACK 10822101
- H16 BRIDLE WHITE 20820011
- H16 BRIDLE BLACK 20822011
- SHACKLE 10700000
- SHACKLES (FOR H14 WITH BOW PLATES) 10870000

### H16 TRAPEZE

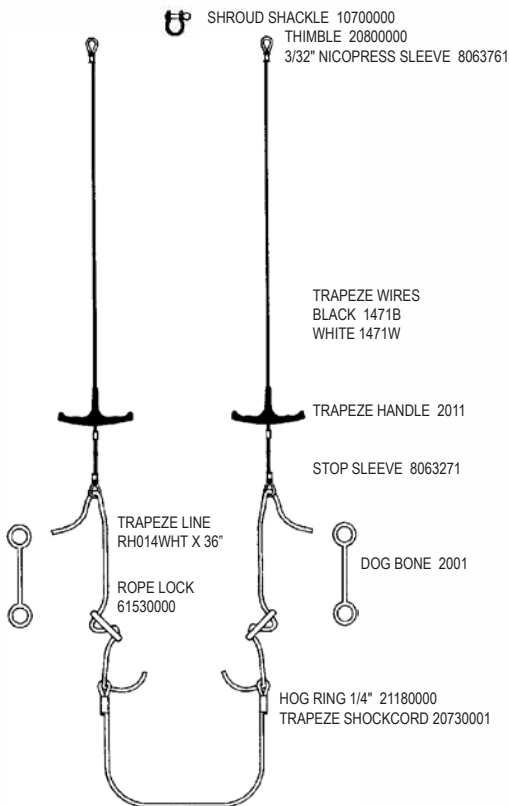

### H14 TURBO RIGGING KIT

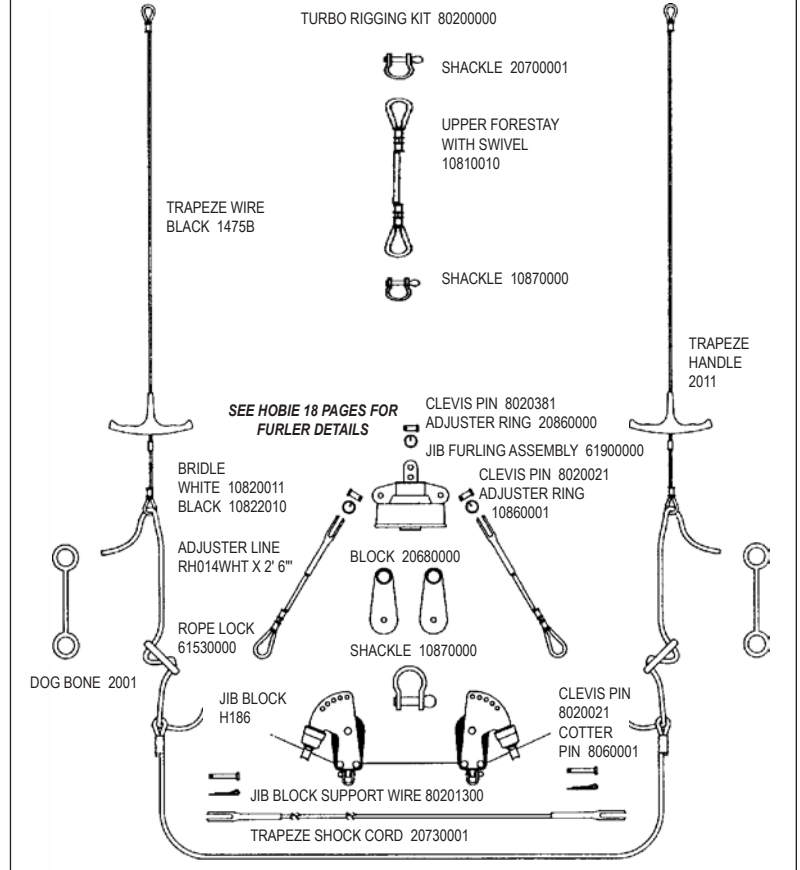

## H14 / H16 MAIN SAIL & BATTENS

H14 MAIN SAIL 1099XXXX  
 H16 MAIN SAIL 20991XXX  
 SEE SEQUENTIAL PARTS LIST  
 OR SAIL COLOR SELECTION SHEET

HEADBOARD W/RIVETS  
 68330011

BATTEN POCKET  
 END PROTECTOR  
 KIT 80550005

"HOBIE"  
 PROTECTOR  
 KIT 12480001

PAIR OF WHITE HOBIE LOGOS 12430001  
 PAIR OF BLACK HOBIE LOGOS 12430001

H14 CLASS INSIGNIA 12440000  
 H16 CLASS INSIGNIA 22330000

SAIL WIND INDICATOR 335

LEECH BATTEN TIP 11323000

LUFF BATTEN TIP 11322011

BATTEN TIE LINE  
 RH112WHT X 18"

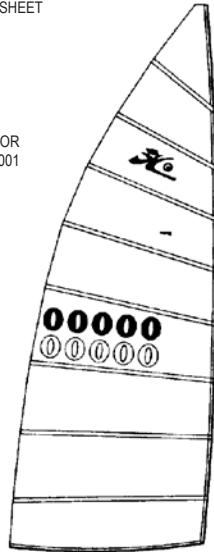

CLEW/TACK PLATE SET 12240000

SAIL BAG/COVER 21310000

### SAIL NUMBERS

BLACK	
#0	12700030
#1	12710030
#2	12720030
#3	12730030
#4	12740030
#5	12750030
#6 & #9	12760030
#7	12770030
#8	12780030

### MAINSAIL BATTEN LENGTHS

H16 BATTEN	H14 BATTEN
#8 41"	
#7 59 1/8"	
#6 72 1/8"	#6 42 11/16"
#5 82 3/8"	#5 60 7/16"
#4 90 3/4"	#4 74 1/16"
#3 97 3/8"	#3 84 13/16"
#2 103 7/8"	#2 93 5/16"
#1 107 7/8"	#1 97 7/16"

H16 MAIN BATTEN SET 21000001  
 (FOR INDIVIDUAL BATTENS SEE UNIVERSAL BATTENS PAGE)

OUTHHAUL LINE RH316WHT X 74"

## H14 / H16 JIB SAIL & BATTENS

H14 JIB 10992XXX SEE SEQUENTIAL PARTS LIST  
 H16 JIB 20992XXX SEE SEQUENTIAL PARTS LIST

JIB HANK W/SCREW  
 22090001

SAIL WIND INDICATOR  
 335

BATTEN POCKET END  
 PROTECTOR 22080905

BATTEN TIE LINE  
 RH112WHT X 18"

JIB SHEET LINE  
 RM516XXX X 32'

BELL SHACKLE 10870000

JIB CLEW BLOCK 20680000  
 NEWER CONFIGURATION H224

ADJUSTABLE JIB CLEW PLATE 22240000

JIB LEECH CAP 21333000

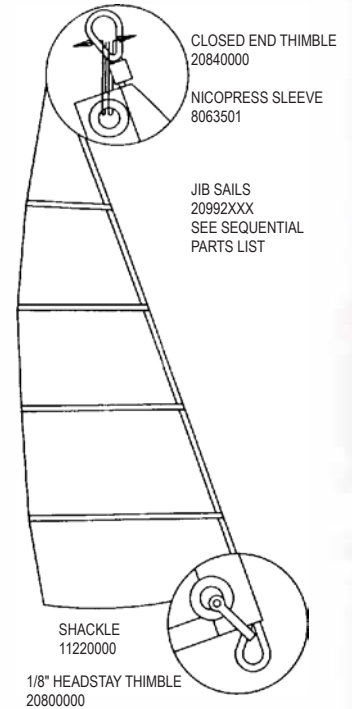

CLOSED END THIMBLE  
 20840000

NICOPRESS SLEEVE  
 8063501

JIB SAILS  
 20992XXX  
 SEE SEQUENTIAL  
 PARTS LIST

SHACKLE  
 11220000

1/8" HEADSTAY THIMBLE  
 20800000

BATTEN #4 30"  
 BATTEN #3 43 3/4"  
 BATTEN #2 57 7/8"  
 BATTEN #1 67"

H14 JIB BATTEN SET 20400001  
 FOR INDIVIDUAL BATTENS SEE  
 UNIVERSAL BATTENS PAGE

## H14 / H16 BOOM

H14 BOOM ASSEMBLY BLACK 10720011  
 H16 BOOM ASSEMBLY BLACK 20720011

REAR END CAP (UNDRILLED BLACK) 10741031 FRONT END CAP BLACK 10740011



BLOCK HANGER  
 10760000

BLACK PLASTIC BARREL CLEAT 10262000  
 STAINLESS V-JAM CLEAT 10261000

GOOSENECK ASSEMBLY  
 10770001

ADJUSTER RING  
 10860001

CLEVIS PIN 8020421  
 NEWER - BOLT 8040001

CLEVIS PIN 8020061

SHACKLE 10772020

"E" CLIP 8062521  
 FOR BOOM PIN  
 THAT IS GROOVED.  
 (OLD STYLE)

NUT 8050121

VERTEX  
 50772031

SLIDE 10772001

"BOOM PIN W/HOLE  
 (W/ROLL PIN) 10772010

ROLL PIN 50502201  
 FOR BOOM PIN  
 THAT HAS A HOLE.  
 (CURRENT STYLE)

BOLT  
 8040021

DOWNHAUL RING 10772070

COTTER PIN 8060101  
 NEWER - NUT 8050101

DOWNHAUL LINE RH316WHT X 5'

## H14 / H16 BLOCK SETS

SHACKLE H138

H14 4:1 BOOM FIDDLE BLOCK H053  
 H14 5:1 DOUBLE w/BECKET H004  
 H16 6:1 UPPER BLOCK H153  
 H16 6:1 UPPER BLOCK H2640\*\*

H14 4:1 MAINSHEET LINE  
 RM038XXX X 36'

H16 6:1 MAINSHEET LINE  
 RM038XXX X 44'

\*\* CURRENT H16 STOCK SETUP

CAMMATIC JAWS  
 H150

ADJUSTMENT SCREW  
 HARKEN JAW ANGLE  
 HFS100

FAIRLEAD 11470000

SHACKLE H138

H14 4:1 FIDDLE BLOCK H060 / H058  
 H14 5:1 H194  
 H16 6:1 LOWER BLOCK H194\*\*

