

HOBIE GETAWAY PARTS

REPLACEMENT HULL - LEFT 37010001
 REPLACEMENT HULL - RIGHT 37020001

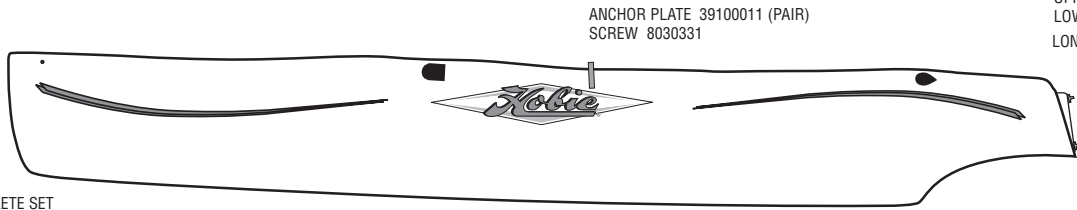

ANCHOR PLATE 39100011 (PAIR)
 SCREW 8030331

EZ LOC RUDDER PINTLES
 UPPER PINTLE 90880211
 LOWER PINTLE 90880221
 LONG LOCK SCREW 8030411

DRAIN PLUG
 W / GASKET 10091000

DECALS -
 37440150 "CURLS" COMPLETE SET
 37440151 "GETAWAY" EACH
 12451031 "HOBIE" DIAMOND 36" TURQUOISE EACH

BOW SPREADER 37500001

BOW TANG 20120000

END BLOCK 37500031
 RIVET 8010201 (4)
 BOLT 8030291
 WASHER 8080671

BOLT 8040341
 NUT 8050311
 PLATE 37500021
 RIVET 8010181

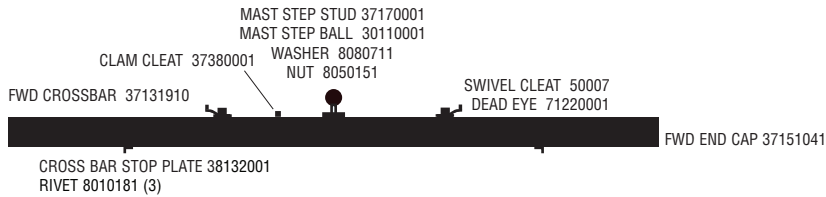

MAST STEP STUD 37170001
 MAST STEP BALL 30110001

CLAM CLEAT 37380001

WASHER 8080711
 NUT 8050151

SWIVEL CLEAT 50007
 DEAD EYE 71220001

FWD CROSSBAR 37131910

FWD END CAP 37151041

CROSS BAR STOP PLATE 38132001
 RIVET 8010181 (3)

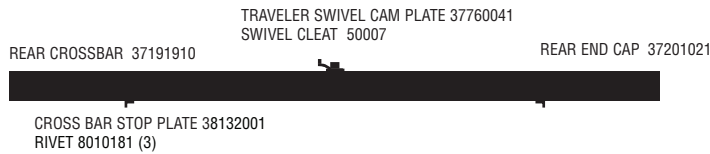

TRAVELER SWIVEL CAM PLATE 37760041
 SWIVEL CLEAT 50007

REAR END CAP 37201021

REAR CROSSBAR 37191910

CROSS BAR STOP PLATE 38132001
 RIVET 8010181 (3)

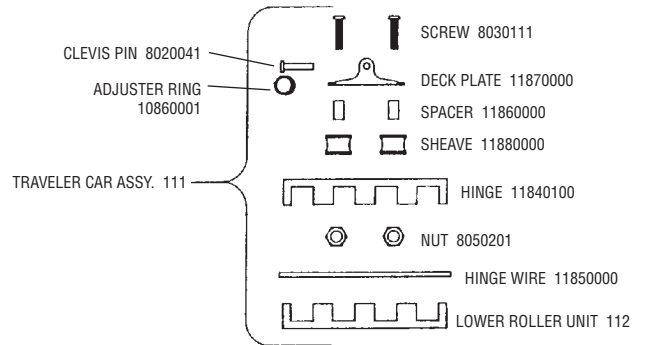

CLEVIS PIN 8020041

ADJUSTER RING
 10860001

TRAVELER CAR ASSY. 111

SCREW 8030111

DECK PLATE 11870000

SPACER 11860000

SHEAVE 11880000

HINGE 11840100

NUT 8050201

HINGE WIRE 11850000

LOWER ROLLER UNIT 112

COOLER LID 37370021
 MOUNT GASKET 37370031
 SCREWS 8031151
 5" HATCH 41370001

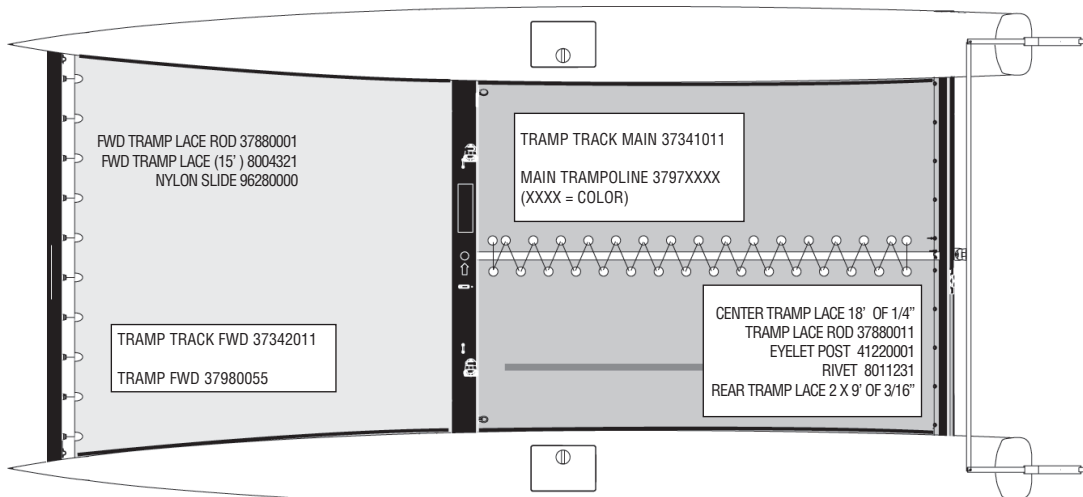

FWD TRAMP LACE ROD 37880001
 FWD TRAMP LACE (15') 8004321
 NYLON SLIDE 96280000

TRAMP TRACK MAIN 37341011
 MAIN TRAMPOLINE 3797XXXX
 (XXXX = COLOR)

TRAMP TRACK FWD 37342011
 TRAMP FWD 37980055

CENTER TRAMP LACE 18" OF 1/4"
 TRAMP LACE ROD 37880011
 EYELET POST 41220001
 RIVET 8011231
 REAR TRAMP LACE 2 X 9' OF 3/16"

FIBERGLASS EXTENSION WITH HINGE 20550001 (84")
(GETAWAY OEM CUT TO 60")

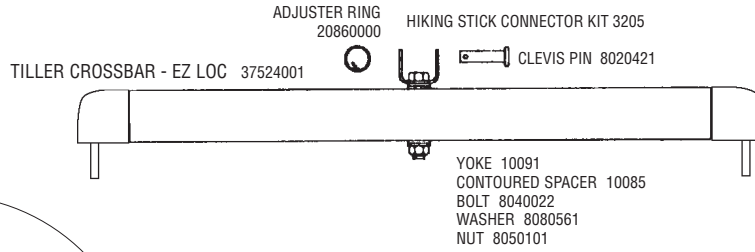
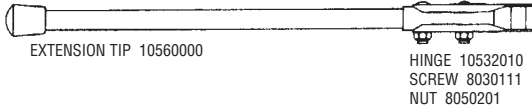

MAST ASSEMBLY 37610000

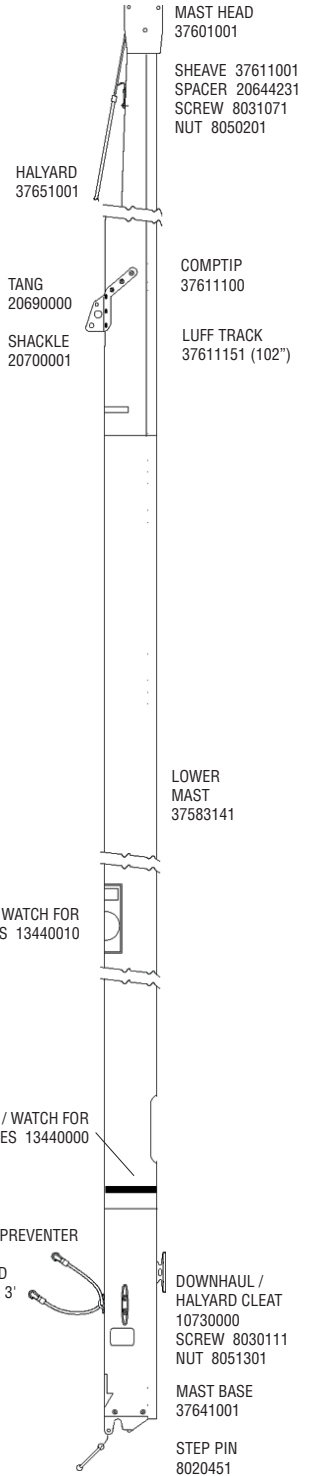

TILLER CONNECTOR 1957

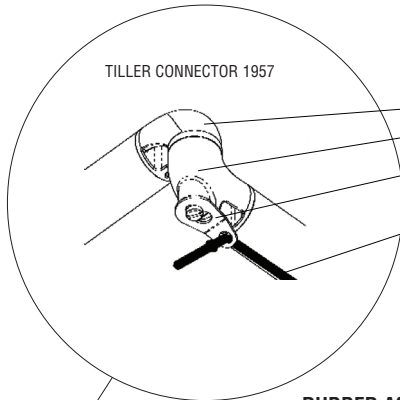

RUDDER ASSEMBLY - EZ LOC
37312000

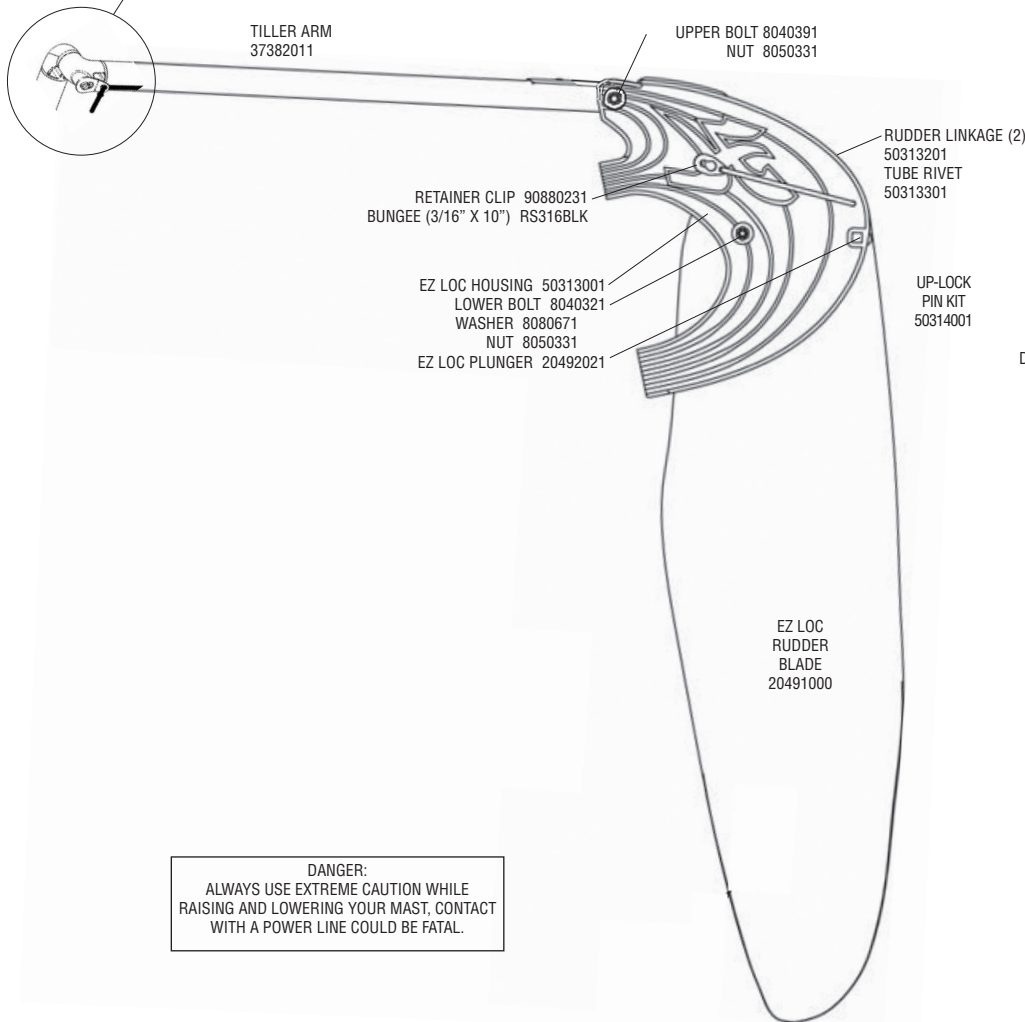

DANGER:
ALWAYS USE EXTREME CAUTION WHILE RAISING AND LOWERING YOUR MAST. CONTACT WITH A POWER LINE COULD BE FATAL.

FORESTAY / BRIDLES



FORESTAY ASSY 37810001

FORESTAY ASSY INCLUDES:
 *SHACKLE W/KEEPER WIRE 20700001
 *SWIVEL 61230000
 *YOKE 37810030
 *SCREW HSPAP
 *LOCK NUT 8050111
 *LOWER FORESTAY 37810021

FURLER ASSY. 61900000

ADJUSTER GETAWAY 20830020

BRIDLE CLEVIS PIN 8020021 RING 10860001

FORESTAY CLEVIS PIN 8020371 RING 20860000

BRIDLE WIRE 37822011

ROLLER FURLER DETAIL

FURLER TUNE UP KIT 61900900
 INCLUDES: BEARINGS, BEARING CAGE, NYLINER, NYLON SLEEVE, DARBY RINGS, SPOOL, HOUSING



CLEVIS PIN 8020371 RING 20860000



SHACKLE 10700000

ADJUSTER 20830020



NYLINER 8061101



NYLON SLEEVE 61940000



YOKE 61980000



SPOOL & HOUSING SEE BELOW



SLEEVE 61950001



DARBY RING 8062511



BEARING RACE 61920000



BEARINGS (REQUIRES 18) 61670000
 BEARING CAGE 61930000



BEARING RACE 61920000



DARBY RING 8062501



TUBE 61910000



SPOOL & HOUSING 61960001

FURLER ASSY. 61900000

NOT SHOWN

LINE RH018WHT X 18' SCREW 8030501

SHROUDS



SHACKLE 20700001



SHROUD 37790001



CLEVIS PIN 8020381 RING DING 20860000

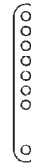

7 HOLE STAY ADJUSTER 20830010

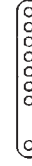

CLEVIS PIN 8020371 RING DING 20860000



LEECH BATTEN TIP (TOP) 21333000



LEECH BATTEN TIP 11323000



LUFF BATTEN TIP 11322011



BATTEN TIE LINE RH112WHT X 18"

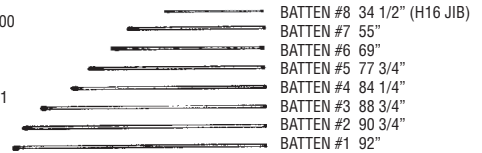

37016001 BATTEN SET

(FOR INDIVIDUAL BATTENS SEE UNIVERSAL BATTENS IN CATALOG)

BATTEN #8 34 1/2" (H16 JIB)
 BATTEN #7 55"
 BATTEN #6 69"
 BATTEN #5 77 3/4"
 BATTEN #4 84 1/4"
 BATTEN #3 88 3/4"
 BATTEN #2 90 3/4"
 BATTEN #1 92"

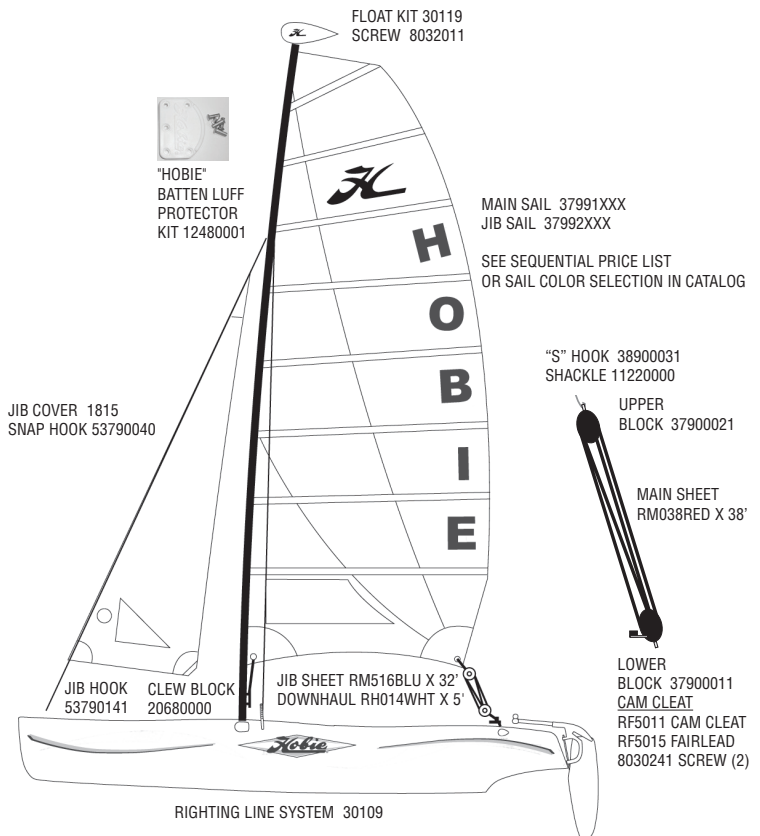

FLOAT KIT 30119 SCREW 8032011

"HOBIE" BATTEN LUFF PROTECTOR KIT 12480001

MAIN SAIL 37991XXX
 JIB SAIL 37992XXX

SEE SEQUENTIAL PRICE LIST OR SAIL COLOR SELECTION IN CATALOG

"S" HOOK 38900031 SHACKLE 11220000

UPPER BLOCK 37900021

MAIN SHEET RM038RED X 38'

LOWER BLOCK 37900011 CAM CLEAT RF5011 CAM CLEAT RF5015 FAIRLEAD 8030241 SCREW (2)

JIB COVER 1815 SNAP HOOK 53790040

JIB HOOK 53790141

CLEW BLOCK 20680000

JIB SHEET RM516BLU X 32' DOWNHAUL RH014WHT X 5'

RIGHTING LINE SYSTEM 30109

MODEL / YEAR / ACCESSORY VARIATIONS

TILLER CROSSBAR 37521001 (OLDER RUDDER CASTINGS / M20 STYLE CONNECTORS)
 TILLER CROSSBAR 37522001 (OLDER RUDDER CASTINGS / TENDON STYLE CONNECTORS)
 TILLER CROSSBAR 37523001 (EZ LOC RUDDERS / TENDON CONNECTORS)

OLDER TILLER CONNECTOR PARTS

CLUB TILLER CONNECTOR (1954 / 1956)

TILLER ARM SWIVEL END CAP 40650001
 TILLER CONNECTOR SCREW 40530021
 INSERT BEARING 40680001
 TILLER ARM INSERT 40660001
 BOLT 8040171
 WASHER 8080691

1956 KIT - CLUB TILLER CONNECTOR
 (REPLACES TENDON STYLE WITH CLUB BOLT STYLE)

1954 KIT - CLUB TILLER CONNECTOR / UPGRADE FOR EARLY BOATS
 WITH ORIGINAL CURVED TENDON CONNECTORS:
 INCLUDES TILLER CROSS BAR AND ALL TILLER CONNECTOR FITTINGS

TENDON TILLER CONNECTOR

ENDCAP 37561001
 FIBER TENDON 37561011
 FIBER-TENDON SCREW 8030071
 QUICK PIN 8020461
 LANYARD 37661091

RUDDER PARTS

Pre-"EZ LOC" Rudder System
 * = SUB ASSEMBLY PART / INCLUDED WITH CASTING

TILLER ARM 37321111 *BOLT 8040301 *WASHER 8080181
 *CAM 10480000
 *PIN 50312301 *CAM PLATE 20352000
 LOWER CASTING BLACK 50322001
 RUDDER PIN BUSHING UPPER 8062001 LOWER 38360001
 *RAKE ADJUSTMENT SCREW 8032001
 *PLUNGER 50312201
 *SPRING 10430000
 *TENSION SCREW 60450000

UPPER CASTING BLACK LEFT 50321001 RIGHT 50341001
 RUDDER BLADE 20493000 WHITE
 BOLT 8040331
 NUT 8050311

ALUMINUM RUDDER CASTINGS
 UPPER PINTLE 38101301
 LOWER PINTLE 38101401
 KEEPER PIN W/ LANYARD 38490011

37001000 GETAWAY WING ASSEMBLY (WITH COVER)

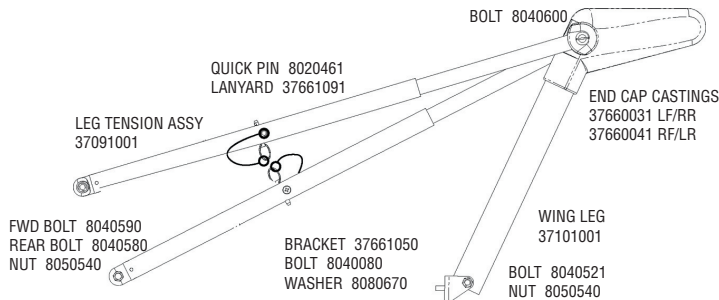
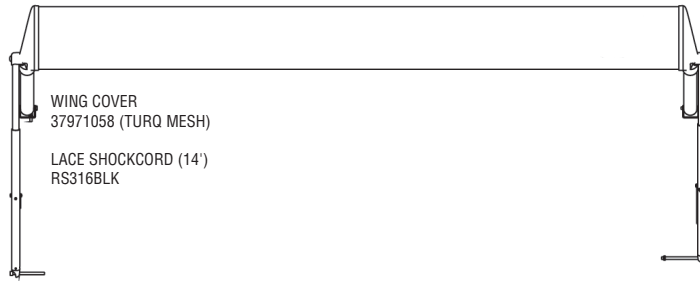

Getaway Rivet Guide

() indicates quantity needed to fasten part

Mast

Head	8010121 (2)
Halyard Hook	8011231 (2)
Tang	8010121 (12)
	8011291 (12)
Bungee Pad Eye	8010181 (2)
	8011291 (2)
Halyard Cleat	8010121 (2)
	8011291 (2)
Base	8010131 (4)
	8011291 (4)

Bow Spreader Bar

Plates, Bridle Bow Tang	8010181 (4)
Internal Stiffener	8010201 (4)

Main Crossbar

Beam Stop Plates	8010181 (6)
Cleat	8010181 (1)
Padeyes	8010181 (4)
Jam Cleat	8010131 (1)
Cleats, Swivel	8010131 (6)
Padeyes	8010131 (4)
End Caps	8010201 (10)

Rear cross bar

Padeye	8010181 (2)
Beam Stop Plates	8010181 (6)
Cleat Plate	8010131 (4)
Tramp Lace Posts	8010231 (10)
End Caps	8010201 (8)