

BAHIA

LaserPerformance NORTH AMERICA

300 Highpoint Avenue
Portsmouth, Rhode Island 02871
USA
t +1 800 966 SAIL
f +1 401 683 0990

LaserPerformance EUROPE

Station Works, Long Buckby
Northamptonshire NN6 7PF
United Kingdom
t +44 (0) 1327 841600
f +44 (0) 1327 841601

LaserPerformance ASIA

Room 3415
China Merchants Tower
Shun Tak Centre
No. 168-200 Connaught Road Central
Hong Kong
t +852 2902 2818
f +852 2587 7868

LaserPerformance MIDDLE EAST

po Box 18323
Jebel Ali Free Zone
Dubai, UAE
t +9714 881 7190
f +9714 881 7522

LASERPERFORMANCE.COM

All rights reserved. ©2009 LaserPerformance. LaserPerformance and associated logos are trademarks. Laser, SB3, Sunfish, and Dart are trademarks used under license. LaserPerformance reserves the right to make design and/or specification changes to any of their products as part of their continuous development program.



Bahia Parts Locator

LaserPerformance™



Bahia Sails and Spars

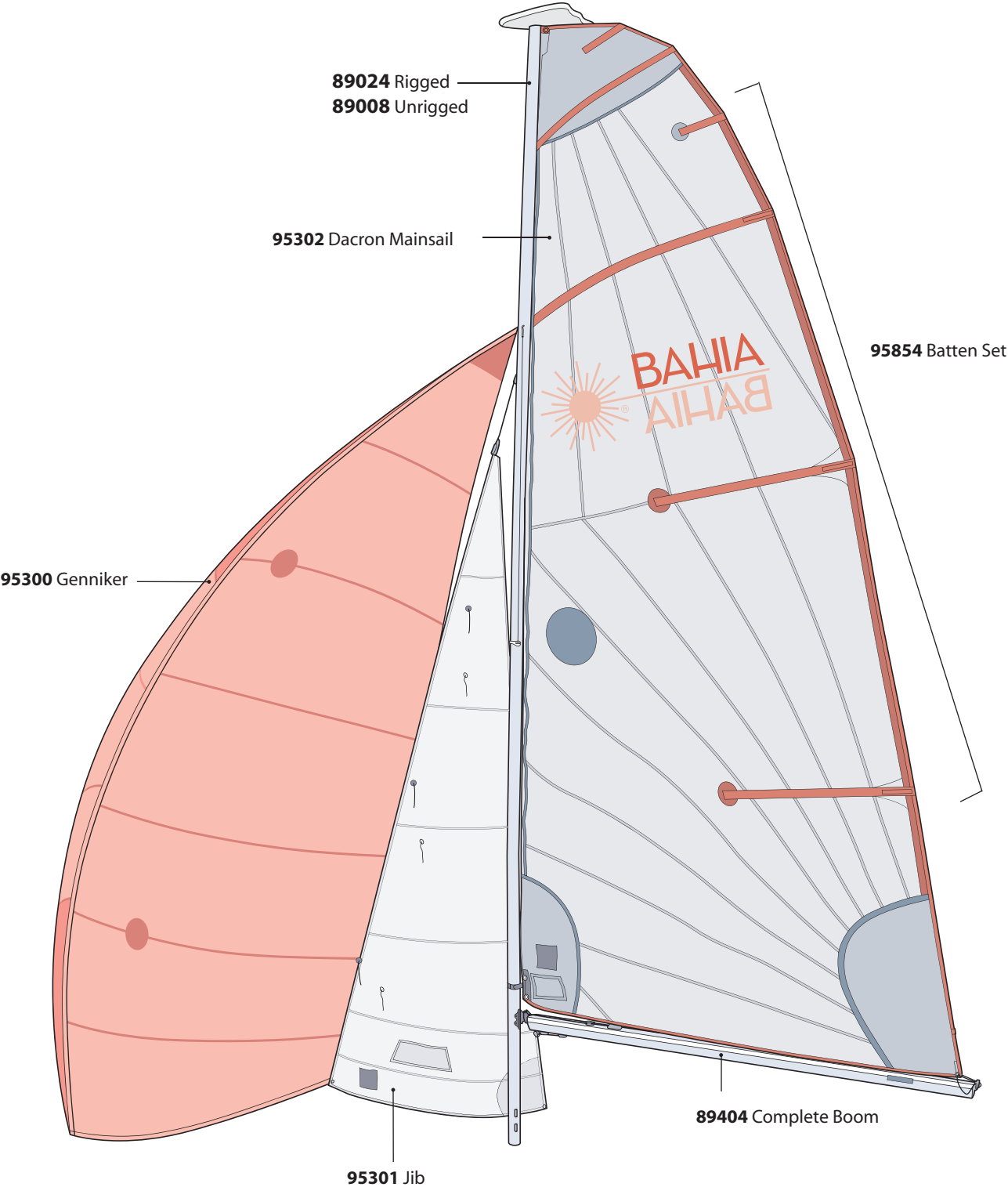

Bahia Hull and Deck Fittings

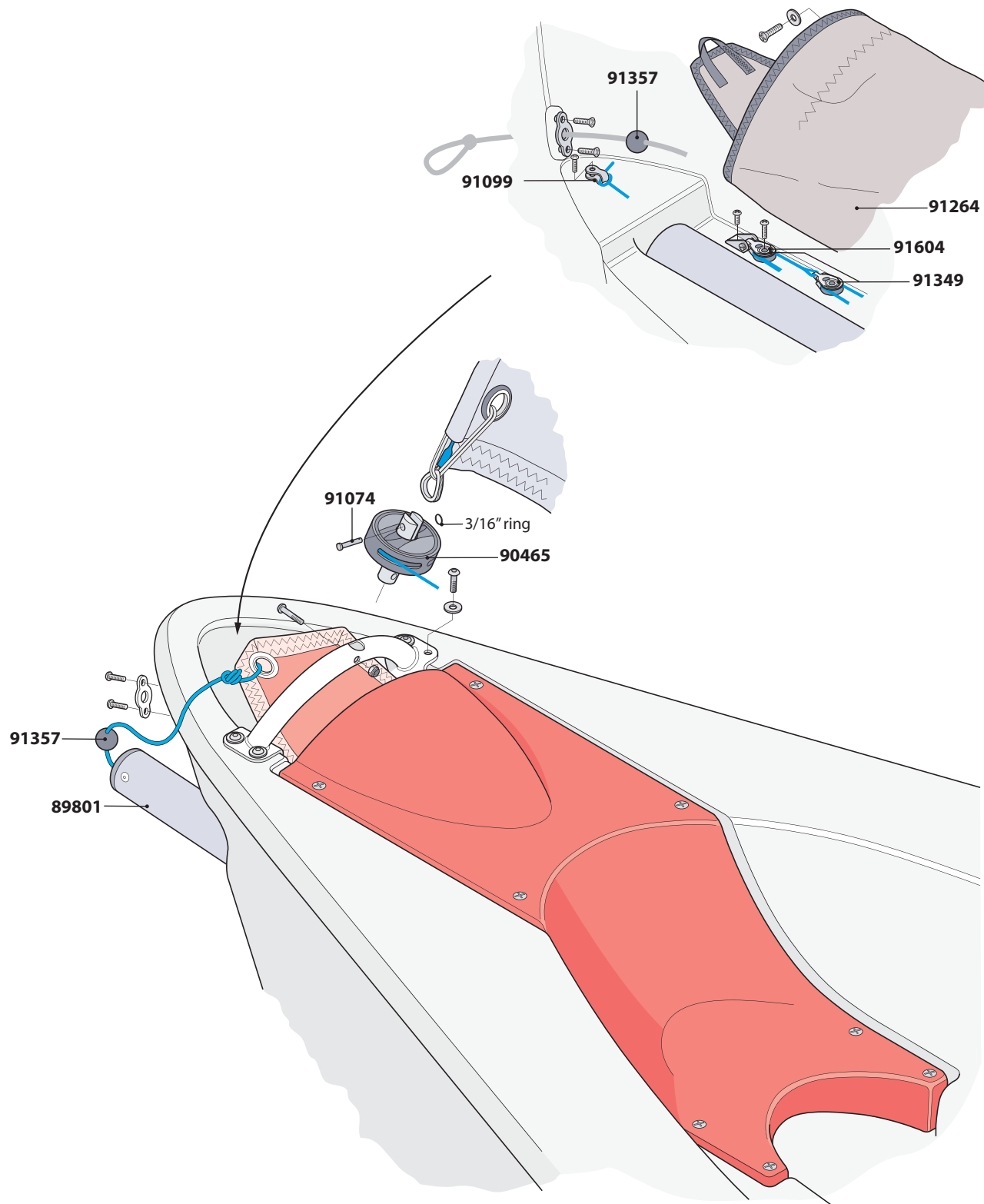

Bahia Hull and Deck Fittings

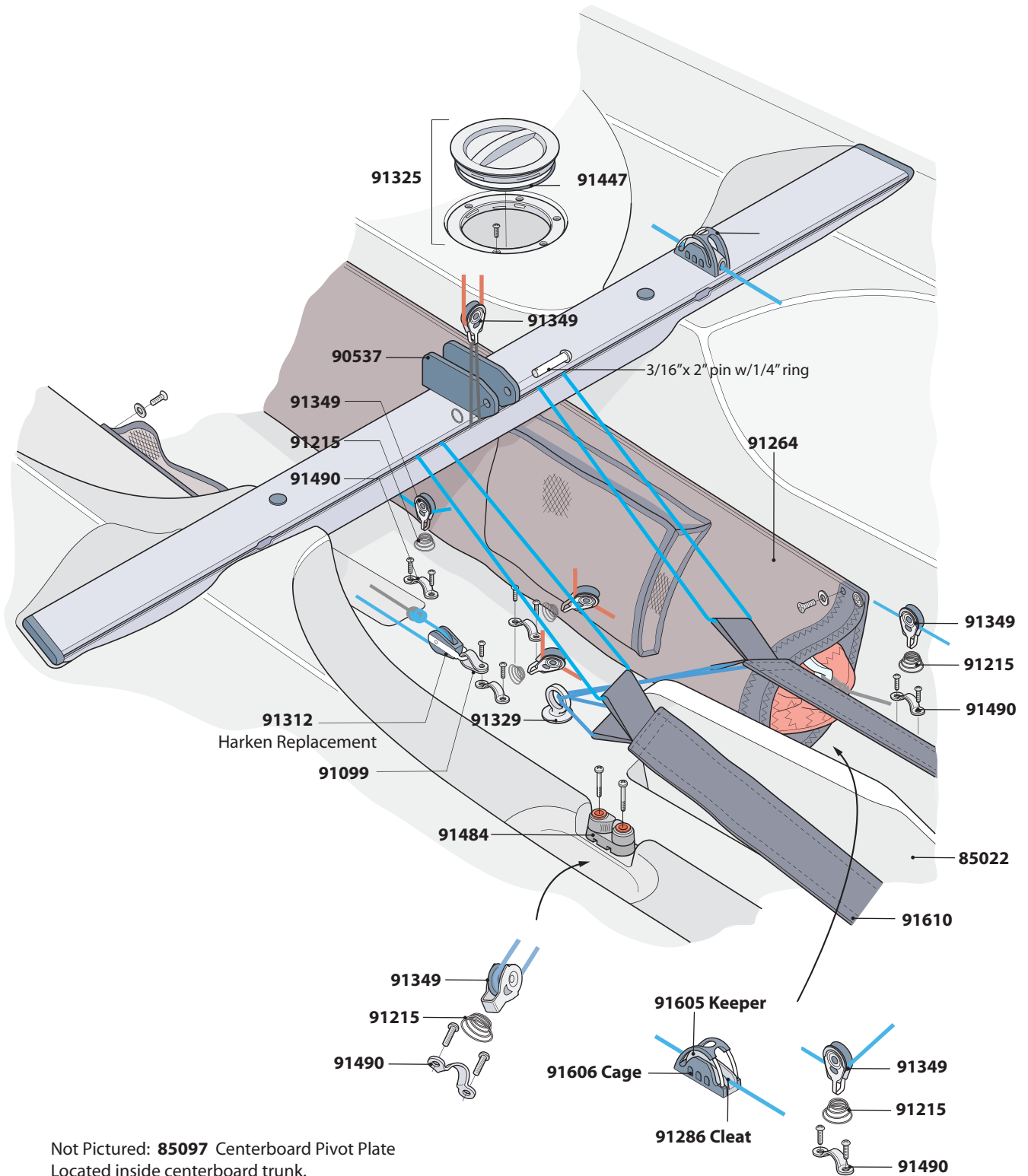

Bahia Hull and Deck Fittings

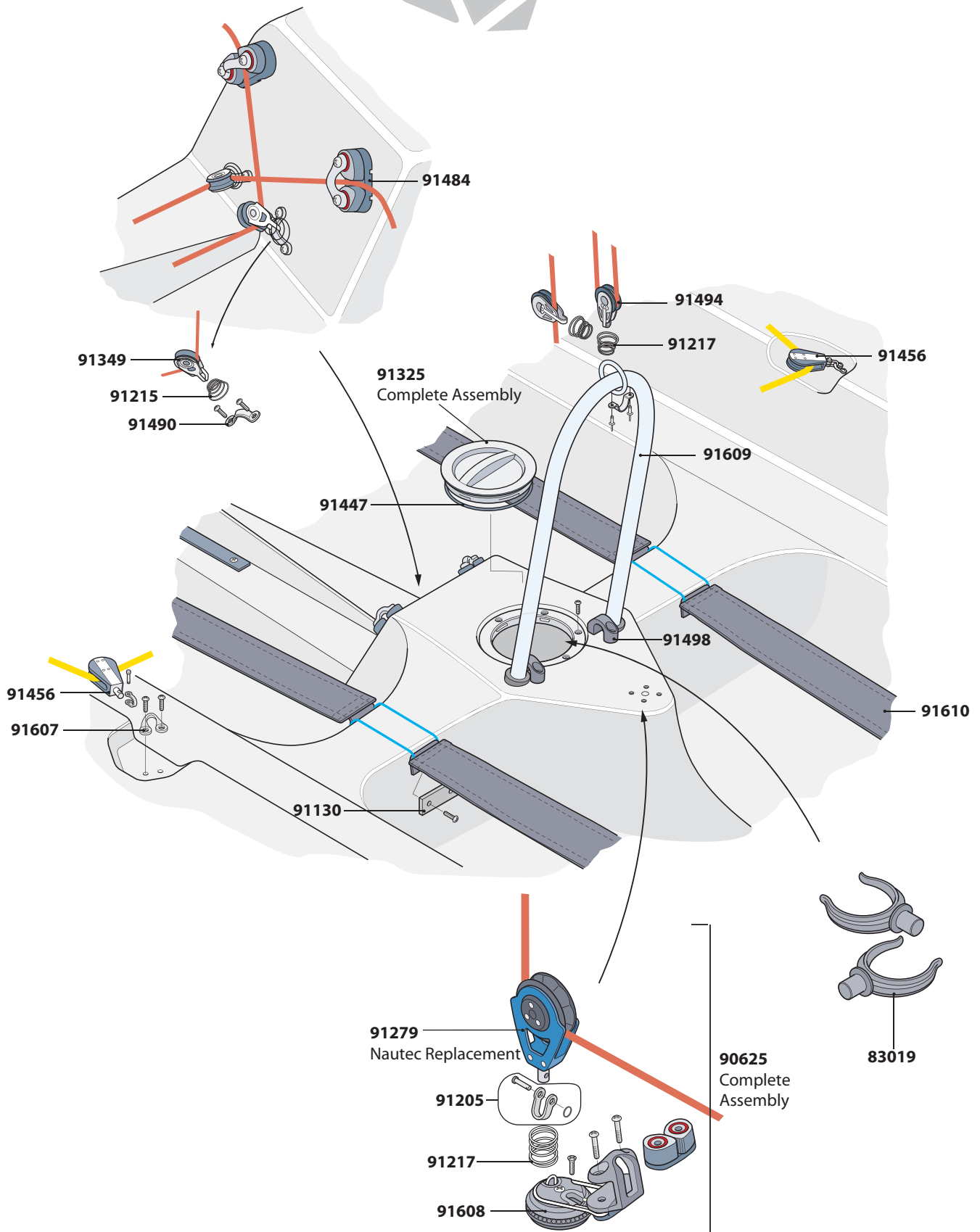

Bahia Transom and Accesories

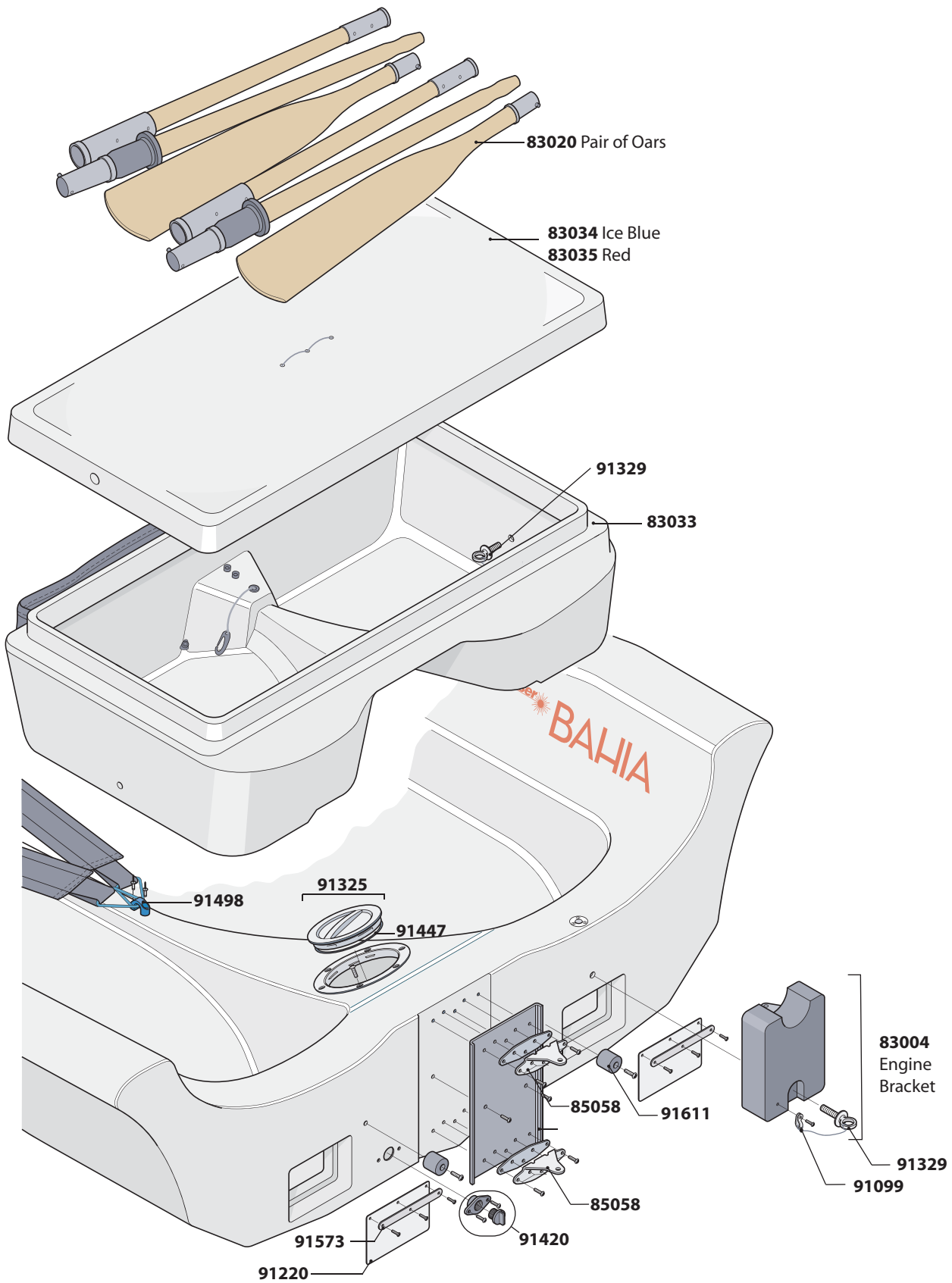



Bahia Spar Hardware

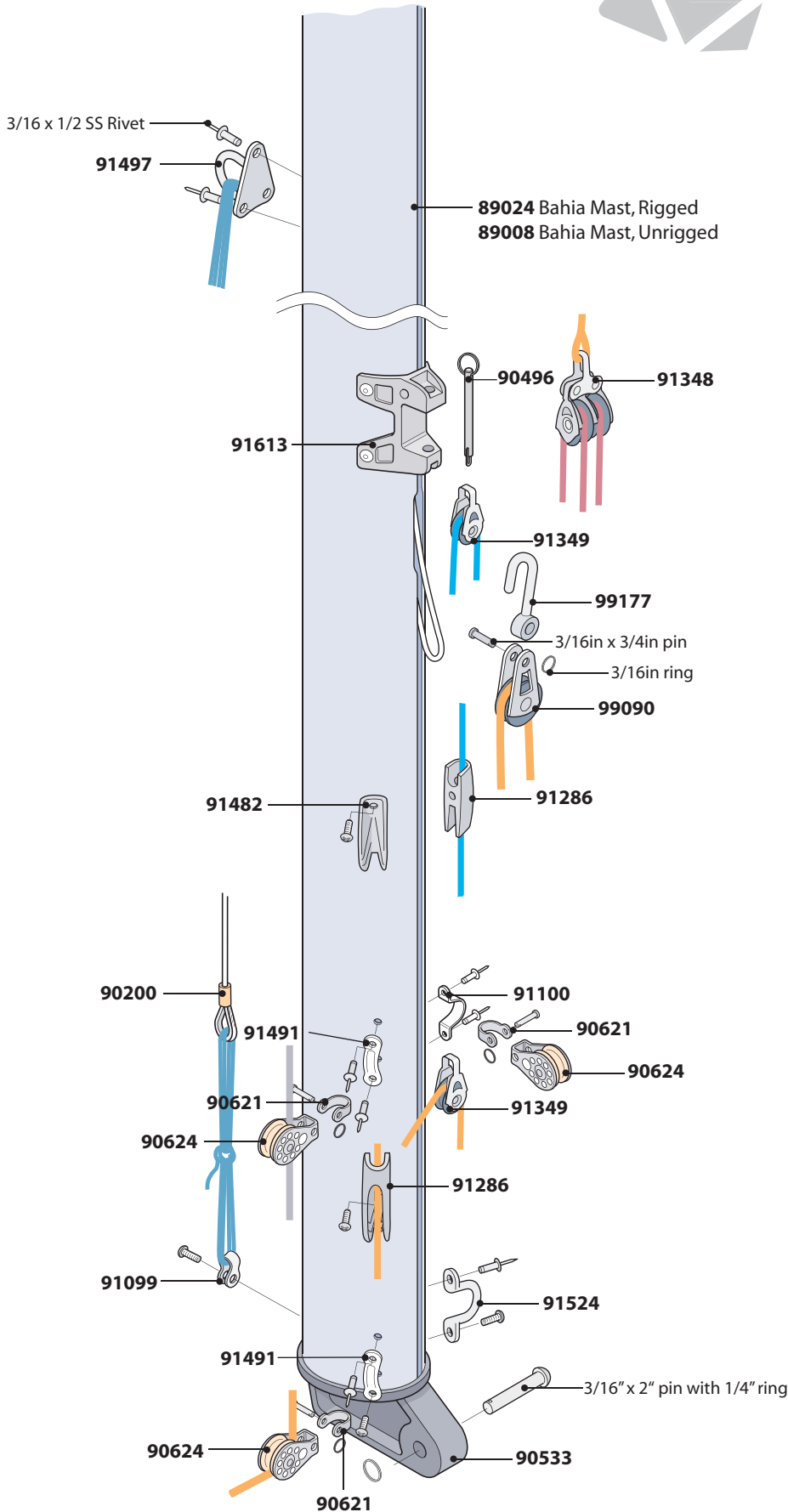



Bahia Spar Hardware

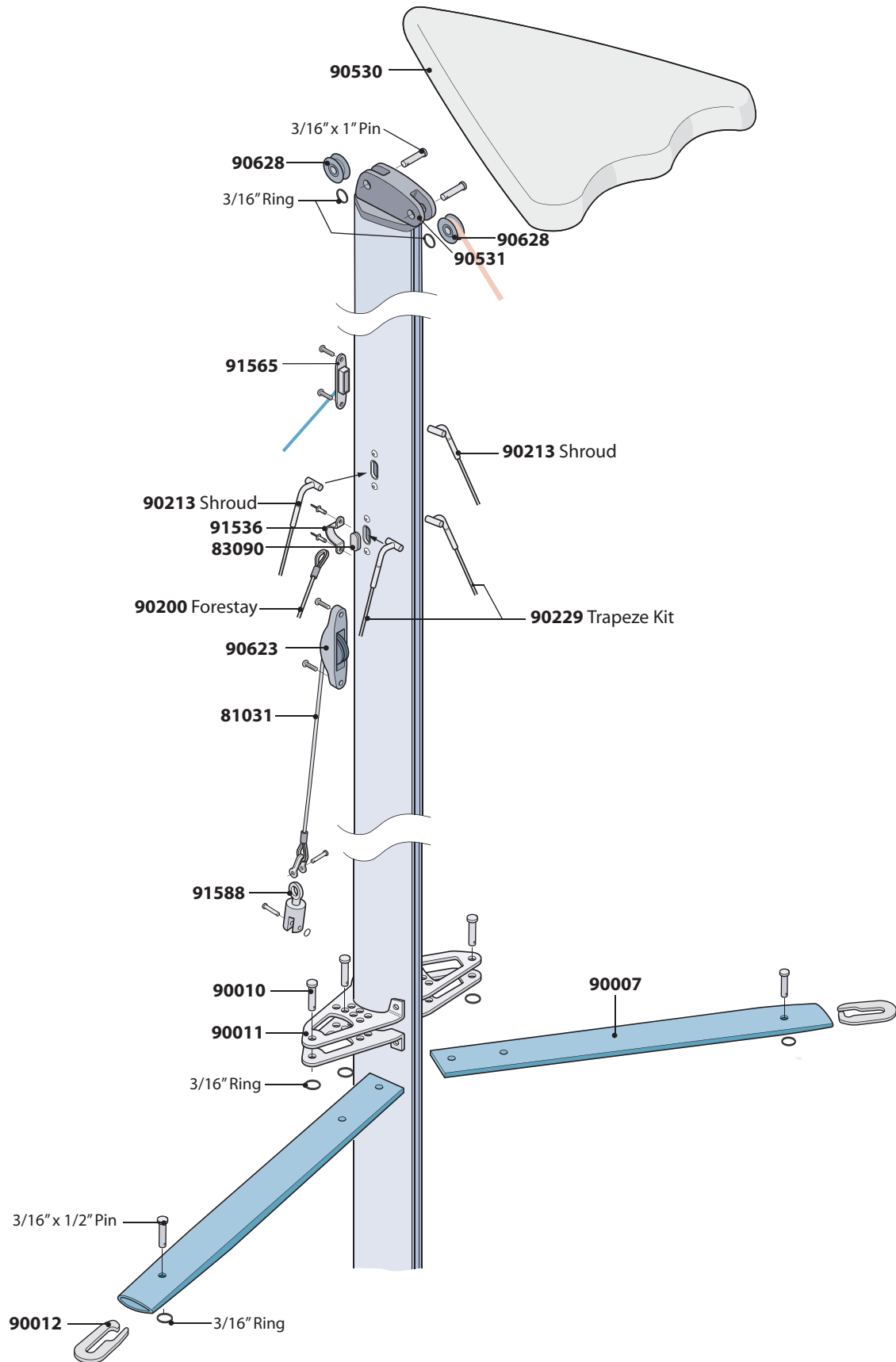

Bahia Hull and Deck Fittings

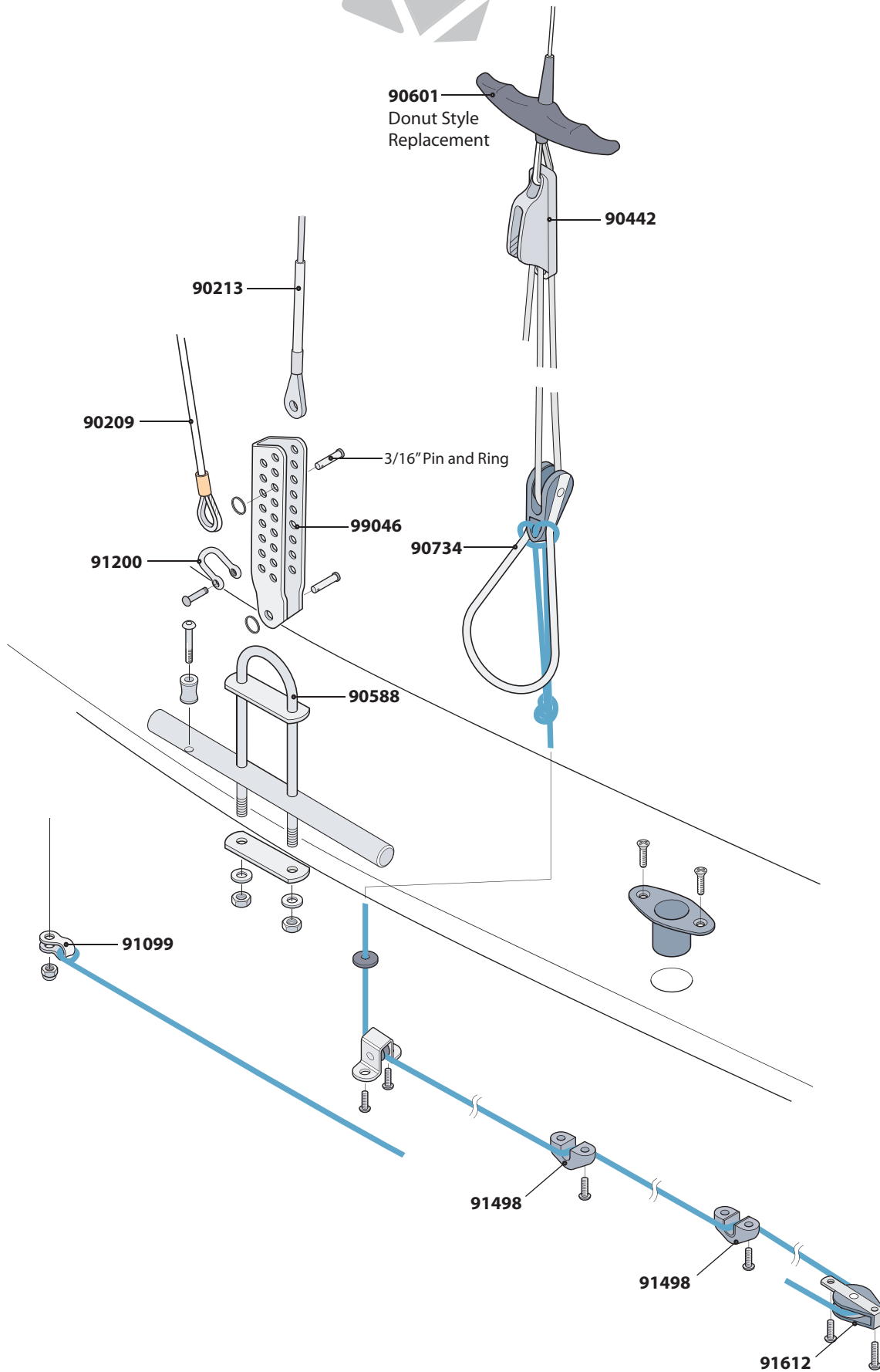

Bahia Boom and Gnav

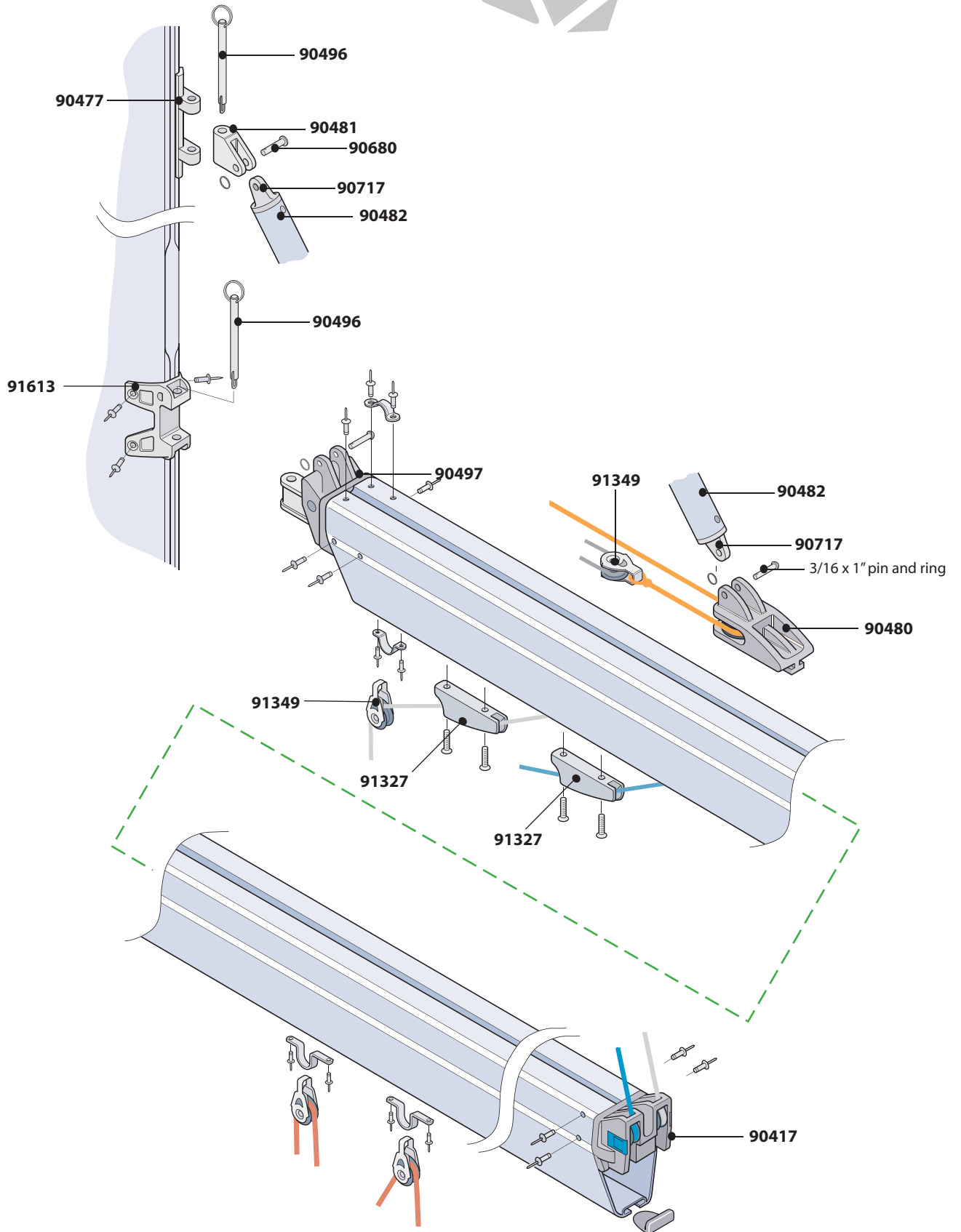



Bahia Technical Information

Hull Weight		286.0 lbs	155 kg		
LOA		15.1 ft	4.6 m		
Beam		5.1 ft	1.8 m		
Draft		3.7 ft	1.2 m		
Main Sail Area		107.6 sq ft	10.0 m sq		
Jib Sail Area		40.9 sq ft	3.8 m sq		
Spinnaker Sail Area		150.7 sq ft	14.0 m sq		

Bahia Line Package

<u>Description</u>	<u>Diameter (in)</u>	<u>Diameter (mm)</u>	<u>Type</u>	<u>Length</u>	<u>Quantity</u>
Centerboard Retainer	1/4 in	6mm	shockcord	2.5 ft	1
Centerboard Rope Handle	3/16 in	5mm	prestretch	1 ft	1
Cunningham Control Line	1/8 in	3mm	prestretch	6.5 ft	1
Cunningham Strop	5/32 in	4mm	prestretch	2 ft	1
Forestay Strop	1/8 in	3mm	Dyneema	4.5 ft	1
Hiking Strap Retainer - Aft	3/16 in	5mm	Spectra	3 ft	1
Hiking Strap Retainer - Front	3/16 in	5mm	Spectra	3.5 ft	1
Hiking Strap Shockcord	3/16 in	5mm	shockcord	4 ft	1
Jib Halyard Purchase	5/32 in	4mm	prestretch	10 ft	1
Lower Shroud Mast Strop	1/8 in	3mm	Dyneema	2.5 ft	2
Lower Shroud Strop	1/8 in	3mm	Dyneema	2.5 ft	2
Main Halyard	3/16 in	5mm	prestretch	41 ft	1
Outhaul	5/32 in	4mm	prestretch	12.5 ft	1
Reef Line - Aft	1/8 in	4mm	prestretch	34.5 ft	1
Righting Line	5/32 in	4mm	prestretch	4.3 ft	2
Rudder Downhaul	3/16 in	5mm	prestretch	7 ft	1
Spinnaker Halyard	5/32 in	4mm	prestretch	54 ft	1
Trapeze Adjuster	3/16 in	5mm	prestretch	10 ft	2
Trapeze Shockcord	3/16 in	5mm	shockcord	10.5 ft	1
Vang Control Line	5/32 in	4mm	prestretch	20 ft	1
Vang Primary	5/32 in	4mm	prestretch	7 ft	1
Sheets					
Jibsheet	5/16 in	8mm	braid on braid	23 ft	1
Mainsheet	5/16 in	8mm	braid on braid	29.5 ft	1
Spinnaker Sheet	9/32 in	7mm	braid on braid	41 ft	1